

11100000500? 5.600 €	
14100000190? 5.650 €	

619000001009		
619000001109		
619000001209		
619000001309		
619000001409		
619000001509		
619000002009		
619000002109		
619000002509		
619000002809		
619000003209		
619000003309		
619000003409		
619000003509		
619000003709		"Blu Colomba"
619000003809		
619000003909		
619000003009		765 €
000000001102		0 €

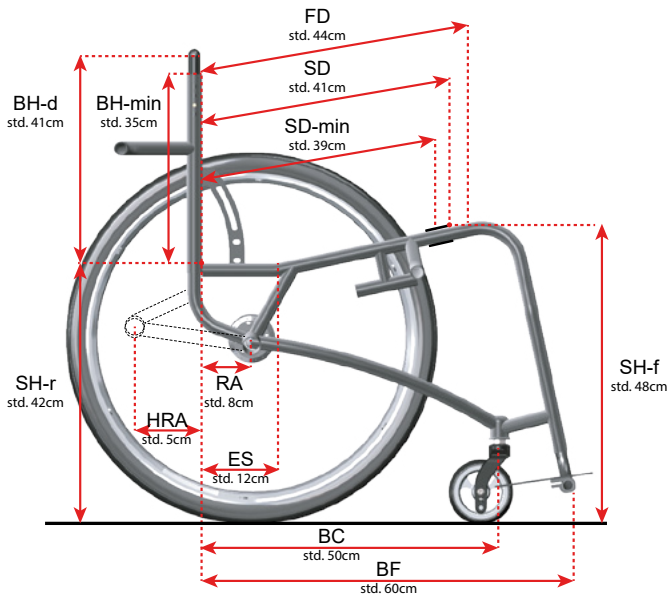

	!		SW: _____ cm
	!		FD: _____ cm SD: _____ cm SD-min: _____ cm
	!		SH-r _____ cm
	!		SH-f: _____ cm
	!		C: _____ °
			BH: _____ cm
	!		BH-d: _____ cm BH-max: _____ cm BH-min: _____ cm
			RA: _____ cm
69100001010? 745 €			HRA: _____ cm
610000001009 610000??0001 260 €		!	ES: _____ cm
			BF: _____ cm
			BC: _____ cm
			CW: _____ cm
			TW: _____ cm

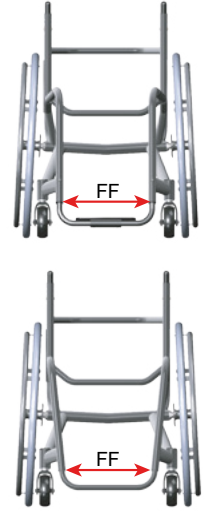
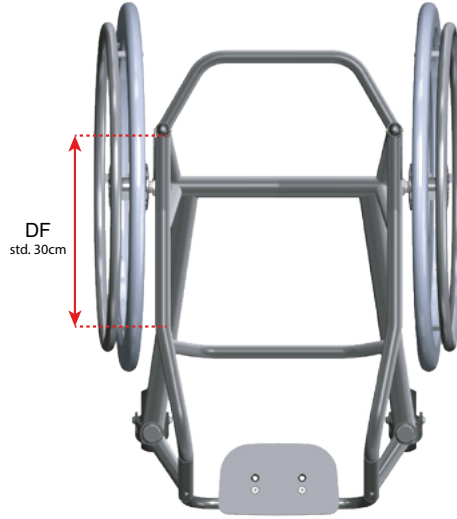
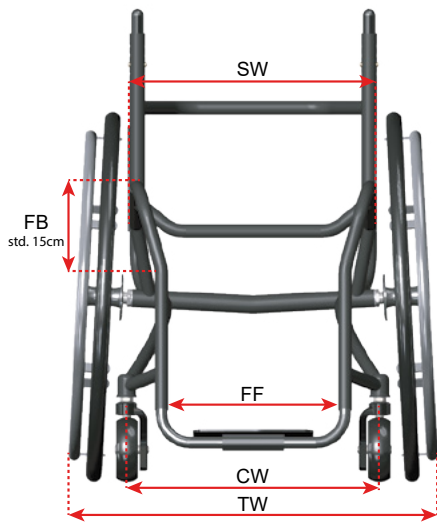

Fill in and send to Wolturnus - Ausfüllen und an Wolturnus senden - Udfyld og send til Wolturnus

Subject to Technical Modifications and Printing Errors / Technische Änderungen und Druckfehler vorbehalten
Forbehold for tekniske ændringer og trykfejl

	!		FF: _____ cm
			FB: _____ cm
	!		FF: _____ cm
			DF: _____ cm
			FF: _____ cm

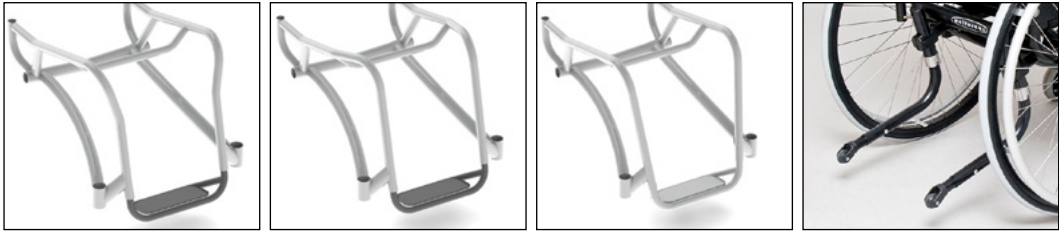

8861101013?? 332 € 8861101013?? 332 €	!		
			AF: _____ cm
			AW: _____ cm
886110102001 332 €			

© Wolturnus A/S WSSL / Dalton Light Summer 2024 v4.1

--	--

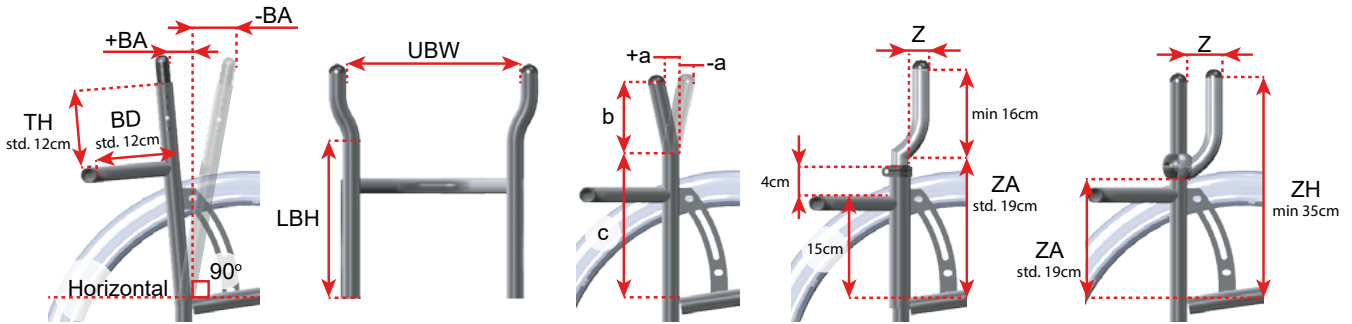

813100050???				
0 €				
813100051???				BA: _____ ±cm
374 €				
691000010130				
70 €				
813100053???				
509 €	!			SW-s: _____ cm

81220020000?				UBW: _____ cm
251 €				LBH: _____ cm
812200200020				a: _____ cm
150 €				b: _____ cm
				c: _____ cm
	!			BD: _____ cm
				TH: _____ cm

8122002001??				
572 €				!
8122002001??				
739 €				
82501000????				_____ cm
572 €	!			ZA: _____ cm
8122002001??				Z: _____ cm
950 €				ZH: _____ cm
8122002001??				
950 €				



--	--

Fill in and send to Wolturnus - Ausfüllen und an Wolturnus senden - Udfyld og send til Wolturnus

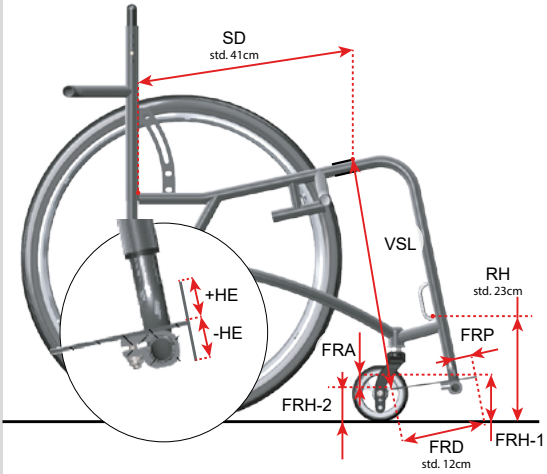

			VSL/USL: _____ cm
			FRH-1: _____ cm
			FRH-2: _____ cm
			-1,5 -3 +1,5 +3
82ØFF00FR00 0 € 144 €			
82??99000000 321 €			Custom FRD _____ cm
829999020004 390 €			HE: _____ ±cm
8299990000?9 0 €			
8299990100?1 278 €			FRD: _____ cm
8299990100?5 230 €			FRA: _____ cm
8299990100?3 536 €			FRD std. 12 cm FRA std. 1 cm
8400100001?? 0 €			
829999020090 235 €			
835099210001 69 €	!		
829999012001 38 €			HE: _____ ±cm
			FRP: _____ cm
691000010001 70 €			RH: _____ cm

--	--

Subject to Technical Modifications and Printing Errors / Technische Änderungen und Druckfehler vorbehalten
Forbehold for tekniske ændringer og trykfejl









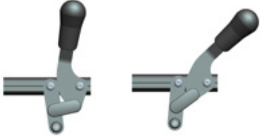

© Wolturnus A/S WSSL / Dalton Light Summer 2024 v4.1

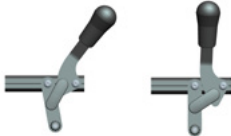
761000000010 250 €							
		+0	1+	2+	3+	4+	5+
		+0	1+	2+	3+	4+	5+

710000000001 0 €							
710099990010 450 €							
710099990012 480 €							
710099990013 480 €							
710099990011 480 €							

710099990001 0 €							
710099990003 189 €							
710099990004 189 €							
710099990002 189 €							
710099990000 0 €							

750000009000 270 €		!				
- 0 €		_____ cm / _____ cm				
750000000005 70 €	!			5cm Std.	7cm	
				Medium Std.	Hard	

885110101001 0 €			
885110101003 0 €			
885110111001 203 €			
885110122002 60 € 88511012200? 120 €			
885110201009 160 € 885110200909 203 €			
885110101101 203 €			
885110111101 203 €			
951519204000 90 € 184 €			
885110201209 230 €			
885110201300 256 €			
85511020130? 409 €			
951500020019 72 €			
691000020001 175 €			

				
881000100003 0 €				
881000600003 0 €				
881000?0000 347 €				
88100010000? 0 €				
88100040000? 307 €				
8810005000?? 760 €				
88100020000? 741 €				
8810003000?? 818 €				

883124101014 245 €			
681000010002 75 €			
681000010052 75 €			
7670000000?? 174 €			

		GH:	_____ cm
		GL:	_____ cm
		MC:	_____ cm

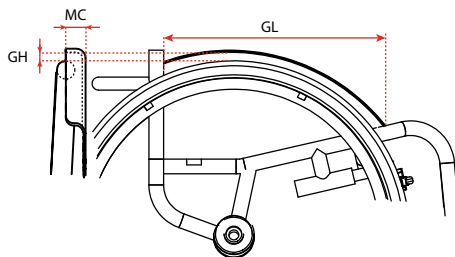

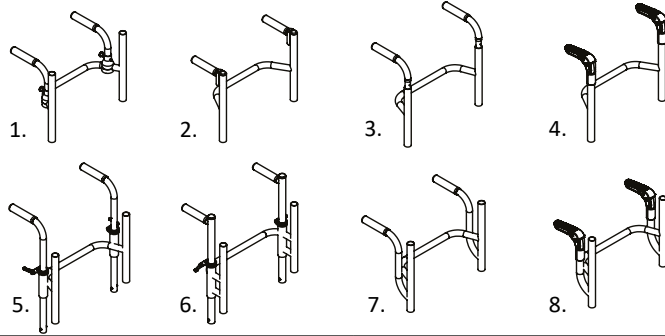

--	--



81310005??09 337 €	1.	
81310005?106 321 €	2.	
81310005?206 375 €		
81310005?108 321 €	3.	
81310005?208 375 €		
81310005?107 187 €	4.	
81310005?207 235 €		

81310005??02 536 €	5.	
81310005??03 536 €	6.	
81310005??04 375 €	7.	
81310005??05 589 €	8.	

		PH: _____ cm
--	--	--------------







69100002002? 280 €		
886210101001 347 €		
7600000100?? 70 € 64 €		
76100000000? 166 € 230 €		
7711000007?? 112 € 112 € 112 €		
771100000747 112 €		
953001040120 112 €		

--	--	--

Fill in and send to Wolturnus - Ausfüllen und an Wolturnus senden - Udfyld og send til Wolturnus



Subject to Technical Modifications and Printing Errors / Technische Änderungen und Druckfehler vorbehalten
Forbehold for tekniske ændringer og trykfejl



© Wolturnus A/S WSSL / Dalton Light Summer 2024 v4.1

966401253410		182 €		
966401003410		182 €		
966401253400		0 €		
966401003400		0 €		
966401003403		0 €		
966401003402		0 €		
966401003401		0 €		
966401003404		0 €		
860020000000		+53 €		
966401250120		332 €		
966401250220		332 €		
966401250320		332 €		
966401250020		332 €		
966401000120		332 €		
966401000220		332 €		
966401000320		332 €		
966401000110		332 €		
966401250?20		386 €		
966401250620		386 €		
966401250520		386 €		
966401250420		386 €		
966401000?20		386 €		
966401000620		386 €		
966401000520		386 €		
966401000420		386 €		
952100000005		0 €		
952100000004		0 €		

--	--

	22"	24"	25"	26"	
85102??01009					0 €
85102?10100?	-			-	0 €
8510??101002				-	263 €
851124201009	-		-	-	481 €

	22"	24"	25"	26"		
85352?101008					915 €	
85352?101208					915 €	
85352?101508	-				915 €	
85352?101308					915 €	
85352?102108					915 €	
85352?101009					710 €	
85352?101209					710 €	
85352?101509	-				710 €	
85352?101309					710 €	
85352?101?09					710 €	

85352?101608					971 €	
85352?101408	-			-	971 €	
85352?101808					971 €	
85352?101708					971 €	
85362?241008					971 €	
85362?241208	-				971 €	
85362?241508					971 €	
85362?241308					971 €	
85362?181008					971 €	
85362?181208	-				971 €	
85362?181508					971 €	
85362?181308					971 €	

85342410042?	-				4.323 €	
85342410043?				-	4.645 €	

--	--

	22"	24"	25"	26"	
96622?010001				-	0 €
96622?01000?					70 €
96622?010009					150 €
96622?010021			-	-	150 €
966224010013	-		-	-	70 €
96622?011008	-			-	70 €
966224010007	-		-	-	70 €

85512?10200?					0 €
85512?102008	-			-	198 €
85502?103009	-				182 €
85552?000009					514 € 643 €
8554202?0601	-				322 €
8554262?0601	-				588 €
8554272?0601	-				588 €
8554282?0601					715 €
9669282?0602					715 €
8554302?0601					715 €
8554502?060?	-			-	715 €
8554502?060?	-			-	715 €

			!		
--	--	--	---	--	--

85712?102009					182 €
--------------	--	--	--	--	-------

--	--	--	--	--	--

000000001104 110 €					
-----------------------	--	--	--	--	--

EN ISO 14971

--	--	--	--	--	--

P.4	
P.5	
P.6	
P.7	
P.9	
P.10	
P.11	
P.12	
P.13	
P.14	

